

# Numerical Study of Inherent Deformation Produced in Thick Plate through Bending by Line Heating<sup>†</sup>

LIANG Wei \*, ITOH Shinsuke\*\*, VEGA Adan\*\* and MURAKAWA Hidekazu\*\*\*

## Abstract

*In ship building, line-heating is widely employed as an effective method to form steel plate with complex 3-dimensional carved geometries. However the plate bending by line heating is strongly dependent on skills. To establish a plate bending method which is less dependent on skill, the deformation produced by single or multilayer heating is necessary.*

*In this report, the distribution characteristic of inherent deformation produced in thick plate by single pass and two-pass overlap heating is discussed. In this report, the three-dimensional FEM using the ISM method is employed. Using the deformation computed by ISM, the inherent deformation produced in thick plate by line heating is estimated through inverse analysis.*

**KEY WORDS: (Line heating), (Inverse analysis), (Inherent Deformation), (Thick Plate)**

## 1. Introduction

In ship building, line heating is widely employed as an effective method to form curved plates with complex geometries. However the plate bending by line heating is a process entirely depending on the skill of workers<sup>1)</sup>.

In recent years, the number of such skilled workers is decreasing with their retirements. This trend is becoming a bottleneck for maintaining high productivity. In addition to this, the thickness of the plate to be formed is increasing due to the increase of the size of ships, such as container ships. This is also a difficulty that shipyards are facing. To solve these problems, a more theory oriented technology-approach which is less dependent on the skill must be developed.

Compared to thin plates, bending of thick plates needs much larger heat input, therefore it is difficult to avoid the overlapping or crossing of heating lines. In order to predict the deformation by elastic analysis with sufficient accuracy, it is necessary to have quantitative information on the distribution of the inherent deformation along the heating line.

In this report, the inherent deformation produced in thick plate through bending using line heating is estimated by inverse analysis. Inherent deformation is estimated according to the following procedure. At first, the deformation of a steel plate under line-heating is computed by thermal-elastic-plastic FEM. In this part, the influences of heat input and overlapped heating on the distribution of the inherent deformation are clarified. Then, the apparent deformation and the inherent deforma-

tion are estimated from the deformation obtained by FEM. The apparent deformation is computed directly from the deformation of the plate as in the case of experiments. The inherent deformations, namely, transverse shrinkage, transverse bending, longitudinal shrinkage and longitudinal bending are estimated through inverse analysis. Finally, the validity of the inherent deformation estimated by the inverse analysis is examined through the comparison between the deformation reproduced by the inherent deformation and that directly computed by the thermal-elastic-plastic FEM.

## 2. Thermal-elastic-plastic FEM Analysis

The procedure to compute the deformation using the thermal-elastic-plastic three-dimensional finite element method is presented in this chapter.

### 2.1 Geometry and FE model

Bending of a thick plate by line heating as shown in Fig.1 is taken as an example. The dimensions of the model are: L=800 mm, B=800 mm and h=40 mm. The plate is uniformly divided into 40 and 4 elements in the line heating and the thickness directions. Figure 2 shows the finite element model. It consists of 6400 brick elements and 8405 nodes. The material of the plate is mild steel. The transient temperature for the moving heat source is computed by the three-dimensional finite element method. The highest temperature on the heating

<sup>†</sup> Received on June 16, 2006

\* Special Appointment Researcher

\*\* Graduate Student

\*\*\* Professor

## Numerical Study of Inherent Deformation Produced in Thick Plate through Bending by Line Heating

surface is kept about 800°C and the temperature on the back surface is varied between 260°C and 340°C depending on the amount of heat input. The plate is assumed to be heated along the x-direction. Temperature

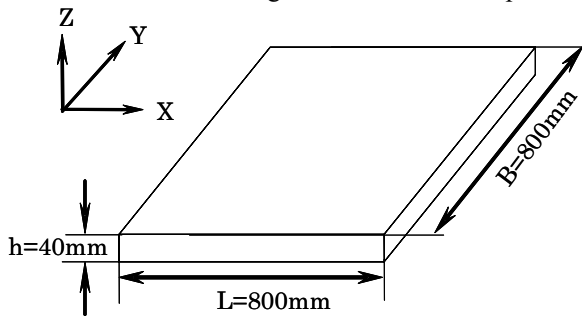

Fig.1 Thick plate model under line heating.

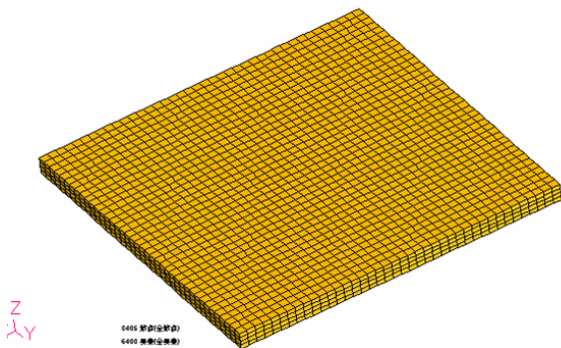

Fig.2 The finite element model.

Table 1 Heating condition.

Case	Heat input (J/mm)	Traveling speed (mm/s)	Surface temperature (°C)	Back surface temperature (°C)
Large	8,250	1.0	800	340
Medium	6,529	1.7	800	300
Small	5,000	3.0	800	260

Table 2 Analysis case

case	pass	Heating input
1	1	Large
2	1	Medium
3	1	Small
4	2	Large-large
5	2	Large-medium
6	2	Large-small
7	2	Medium-large
8	2	Medium-medium
9	2	Medium-small
10	2	Small-large
11	2	Small-medium
12	2	Small-small

### Physical properties

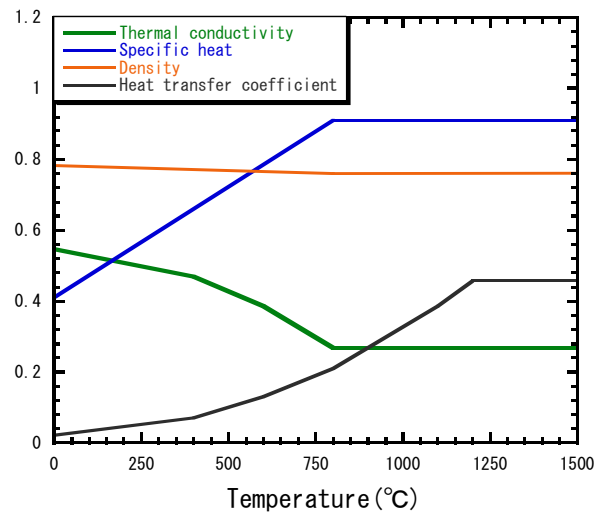

### Mechanical properties

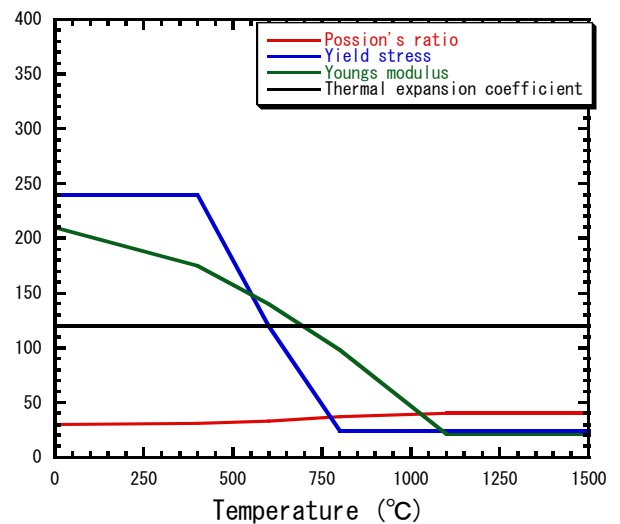

Fig.3 Temperature dependent material properties assumed in analysis.

dependent thermal and mechanical properties shown in Fig.3 are used in the analysis.

To clarify the influence of heat input and overlapped heating, three types of heating condition, namely large heat input, medium heat input, small heat input are taken as examples as shown in Table 1. The computed cases with single and overlapped heating are listed in Table 2. As shown in Table 2, cases from 1 to 3 are one-pass heating on the upper surface. Cases from 4 to 12 are assumed to be heated by two-pass overlapped heating on the upper surface. In the cases of overlap heating, the orders of the line heating with different heat inputs are considered.

### 2.2. Method of analysis

The thermal-elastic-plastic FEM is a powerful tool for predicting welding residual stresses and distortions. But the three-dimensional thermal-elastic-plastic FE analysis

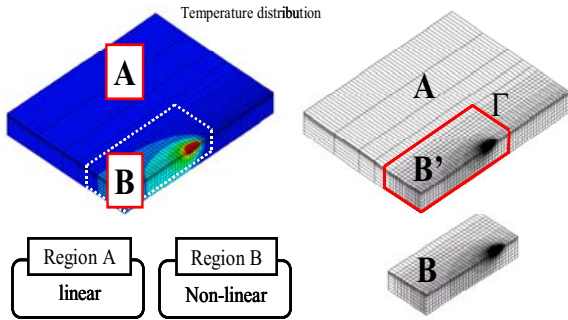

(a)

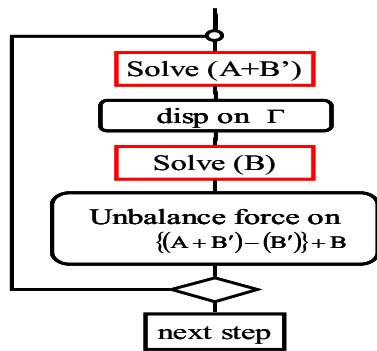

(b)

Fig.4 Concept of iterative substructure method and procedure of iteration.

requires very long computational time and large memory size. To overcome this problem, the iterative substructure method, ISM is employed in this research<sup>2)</sup>.

The iterative substructure method takes full advantage of the fact that the region which exhibits strong nonlinearity is limited to a very small area compared to the size of the model to be analyzed and the remaining part is mostly linear. The model is divided into a non-linear region and the linear region in ISM. As seen from the Fig.4, only a small volume of the model under plastic-loading region B exhibits strong non-linearity and the remaining region A is linear or weakly nonlinear.

The continuity of the traction on the boundary between the linear and the nonlinear regions is maintained through the iterative procedure.

### 2.3 Computed results and discussion

As examples of computed results, the deformation in the z-direction obtained by thermal-elastic-plastic FEM analysis are shown in Fig.5. This figures shows the deformation caused by one-pass heating with medium heat input. Figure 5 (b) shows the result for the two-pass heating with medium heat input. As seen from the figures, the maximum deformation in the Z-direction is about 3.5mm and 5.5mm for one pass with medium heat input and two passes with medium heat input, respectively. As seen from this result, the deformation by the two pass

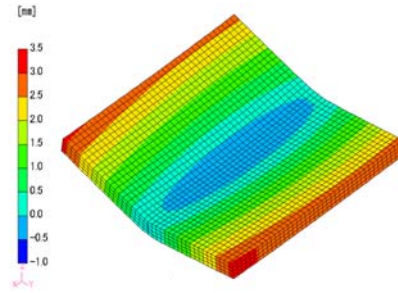

(a) The deformation of case 2.

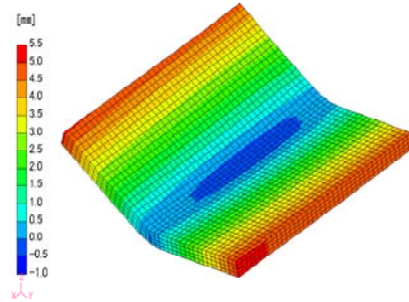

(b) The deformation of case 8.

Fig. 5 Z-direction deformation calculated by thermal-elastic-plastic FEM.

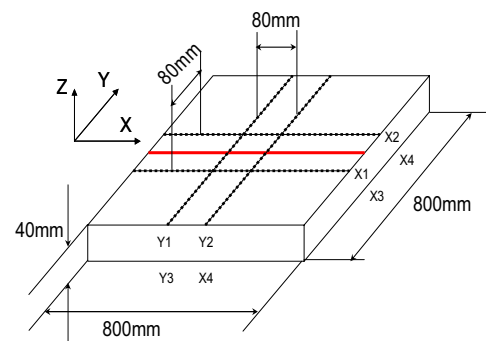

Fig. 6 The definition of apparent deformation.

heating becomes almost twice of that of the single heating. But the increment by the second pass is slightly smaller than that produced by the first pass.

The deformations of the plate are evaluated by two methods. One is by apparent deformation, such as shrinkage between marked two points and the angular distortion. The other is by inherent deformation. The difference between them is that the former includes the elastic deformation while the latter does not.

$$\delta_T = \frac{\{(v_{x1} - v_{x2}) + (v_{x1} - v_x)\}}{2} \quad (1)$$

Where,  $v_{x1}, v_{x2}, v_{x3}, v_{x4}$  are the deformations along the Y direction at points  $x_1, x_2, x_3, x_4$  shown in Figs.6 and 7. The angular distortion can be evaluated also from the deflection.

## Numerical Study of Inherent Deformation Produced in Thick Plate through Bending by Line Heating

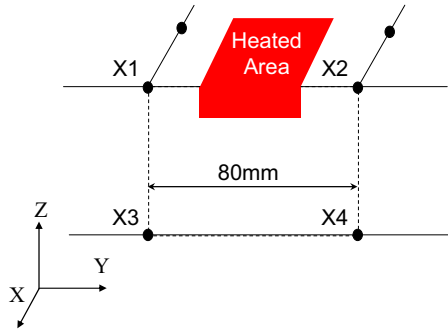

Fig.7 Heated area.

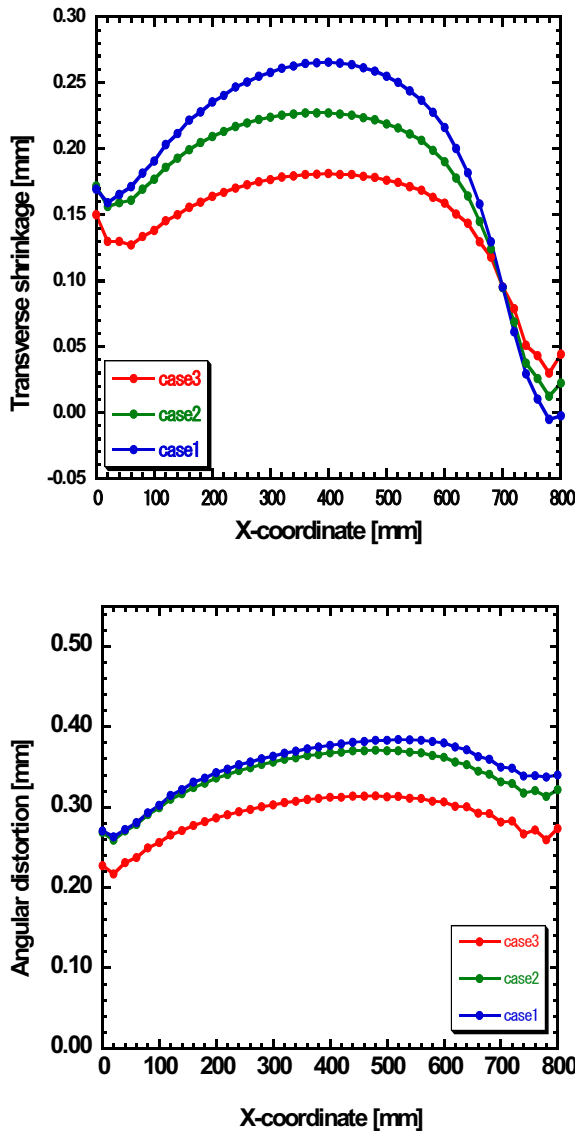

Fig.8 Transverse shrinkage and Angular distortion along the heating line.

The apparent transverse shrinkage  $\delta_T$  along the heating line is calculated according to the following equation:

The transverse shrinkage and the angular distortion for the one-pass heating evaluated by the above equation along the heating line are shown in Fig.8. Figure 8(a)

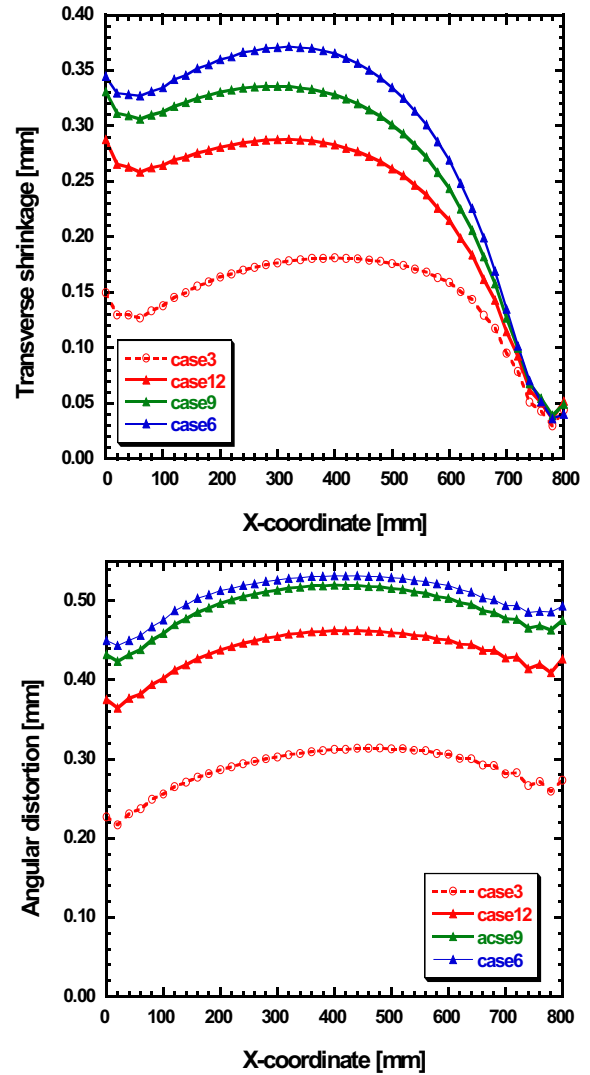

Fig.9 Transverse shrinkage and Angular distortion along the heating line.

shows transverse shrinkage  $\delta_T$  and Fig.8(b) shows the angular distortion  $\theta_T$ . From these figures, it is seen that:

- (1) Significant influence of heat input is observed in transverse shrinkage. With the increase of heat input, the maximum values of the transverse shrinkage increases. On the other hand, the angular distortions for the medium and large heat inputs are larger compared to that for the small heating, but the difference between medium and large heating is small.
- (2) Regarding the distribution, the angular distortion distributes almost uniformly along the heating line, while significant end effects are observed in the transverse shrinkage at both ends. The end effect is more significant at the finishing end.

In order to discuss the influence of overlapped heating, the transverse shrinkage and angular distortion by two-pass heating are shown in Fig.9. From the figure, it is seen that, the same characteristic is observed in the

distribution of the apparent deformation for the two-pass heating as that for one-pass heating.

### 3. Evaluation of Inherent Deformation by Inverse Analysis

#### 3.1 Measurement points for inverse analysis

Inverse analysis is a method to estimate the inherent deformation by measuring the three-dimensional coordinates at a small number of selected points. The points on the thick plate as shown in Fig.10 are selected. By measuring the three-dimensional coordinates of the selected points before and after the line heating, the inherent deformation can be determined<sup>3)</sup>.

The three-dimensional coordinates of measuring points can be obtained by two ways. One is by experiment and the other is by simulation using thermal-elastic-plastic FEM. In his study, the three-dimensional coordinates of measuring points are obtained by the latter.

#### 3.2 Assumptions for inverse analysis

The inherent deformation is determined by inverse analysis under the following assumptions:

- (1) The distortion is assumed to be caused by the four components, namely longitudinal shrinkage  $\delta_L^i$ , transverse shrinkage  $\delta_T^i$ , longitudinal curvature  $\theta_L^i$  and transverse bending  $\theta_T^i$ .
- (2) The distribution of inherent deformation is approximated as uniform distribution.
- (3) The inherent deformation is assumed to distribute in the area along the heating line with the width of 80 mm.

#### 3.3. Computed results and discussion

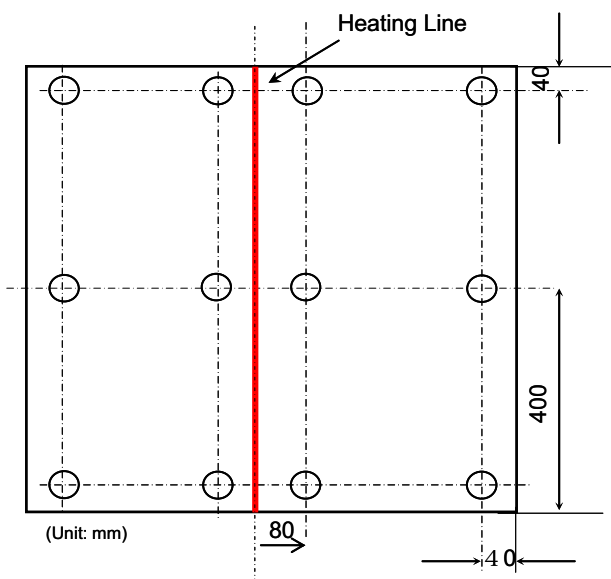
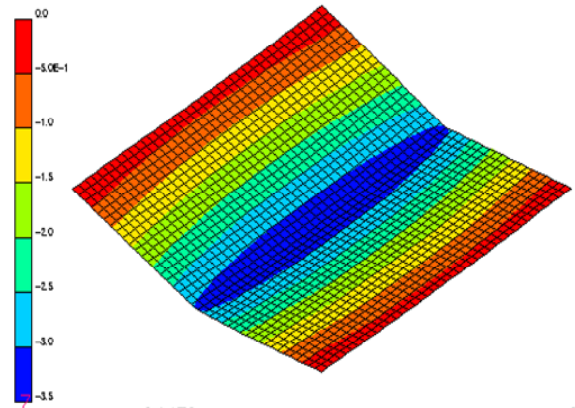
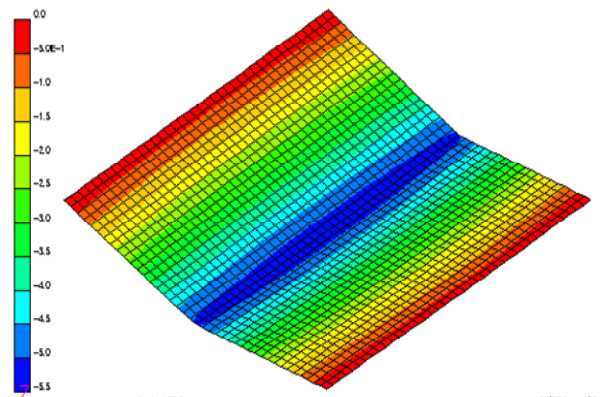

Fig.10 The measure points on the thick plate.



(a) The result of case 2.



(b) The result of case 8.

Fig.11 Distortion calculated by elastic FEM analysis.

Using the coordinates of the ten points measured before and after the line heating, the four components of the inherent deformation are estimated by the inverse analysis described above. Using the estimated inherent deformation, the deformation of the model is computed as a forward analysis.

As one of the results, the distribution of displacement in the z direction is shown in Fig.11. Comparing the deflection reproduced using the inherent deformations with that obtained by the thermal-elastic-plastic FEM shown in Fig.5. The two results show good agreements. These results prove that the four components of the inherent deformation are accurate enough to reproduce the deformation caused by line heating.

The two components of the inherent deformations, namely the transverse shrinkage  $\delta_T^i$  and the longitudinal shrinkage  $\delta_L^i$  can be related to the apparent transverse shrinkage  $\delta_T$  by the following equation.

$$\delta_T = \delta_T^i + \nu \delta_L^i \quad (2)$$

Where  $\nu$  is the Poisson's ratio, noting this relation, the transverse shrinkage and the angular distortion are compared between those estimated directly from the deformation computed by the thermal elastic-plastic FEM



## Numerical Study of Inherent Deformation Produced in Thick Plate through Bending by Line Heating

and the inherent deformation estimated through inverse analysis in Fig.12. As seen from the figures:

- (1) The angular distortion estimated by the two methods show good agreement.
- (2) The transverse shrinkage estimated by the two methods shows good agreement for one pass heating. The difference becomes large in the case of two pass heating. This may be explained by the fact that the end effect becomes more significant for two-pass heating.
- (3) For both transverse shrinkage and angular distortion, the value obtained by thermal-elastic-plastic analysis is slightly bigger than that obtained by inverse analysis.

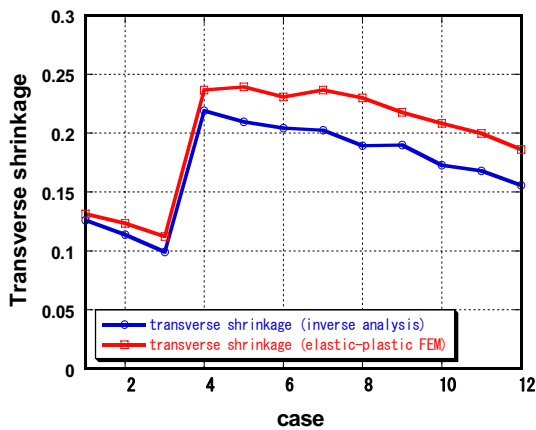

(a) Transverse shrinkage.

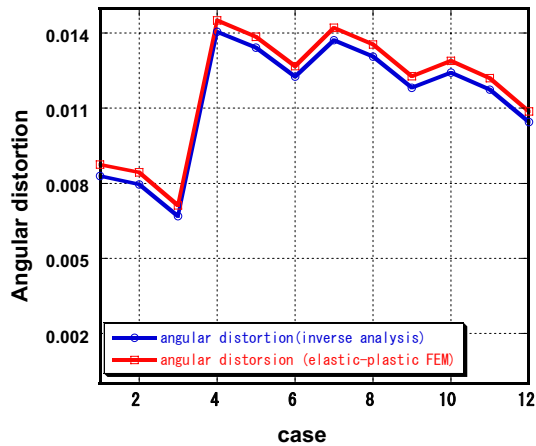

(b) Angular distortion

Fig.12 Comparison of inherent deformation between Inverse analysis and thermal-elastic-plastic Analysis.

## 4. Conclusions

As demonstrated above, the deformation of thick plate by line heating is simulated by thermal-elastic-plastic FEM. Using the computed deformation, the inherent deformation has been estimated by inverse analysis. Through the present work the following conclusions are drawn.

- (1) The angular distortion estimated through the inverse analysis shows good agreement with that directly estimated.
- (2) The same characteristic is observed in the distribution of deformation for the two-pass heating as in the case of on one-pass heating.
- (3) The increment of deformation produced by the second-pass heating is slightly smaller than that by the first heating.
- (4) It is shown that the inherent deformation produced in thick plate by line heating can be estimated by inverse analysis with sufficient accuracy when the end effect is small.
- (5) The transverse shrinkage estimated by the two methods shows good agreement for one pass heating. The difference becomes large in the cases of two pass heating. This may be explained by the fact that the end effect becomes more significant for two pass heating.

## References

- 1) Y. Ueda, H. Murakawa, R.A. Mohamed, R. Kamichika, M. Ishiyama, J. Ogawa: Development of Computer Aided Process Planning System for Plate Bending by Line-heating(4th Report)-Decision Making on Heating condition Location and Direction. Journal of the Japan Society of Naval Architects, 174, pp. 683. (1993)
- 2) H. Nishikawa, H. serizawa, H. Murakawa: Development of large-scaled FEM for Analysis Mechanical Problems in welding. Journal of the Japan Society of Naval Architects, 2 (2005), pp. 379.
- 3) W. Liang, S. Sone, M. Tejima, H. Serizawa and H. Murakawa: Measurement of Inherent Deformation in Typical Weld Joints Using Inverse Analysis (Part1) Inherent Deformation of Bead on Welding, Transactions of JWRI, Vol.33, No.1, pp. 45-51 (2004)